



Fitting Guidelines.

Unfold these guidelines and read all front and rear pages.

To be left with the customer after installation.

Fitting guidelines for the following models:

ALCUDIA

Index.

Front cover.

Fitting guidelines. Page 1 to 9.

Front cover.

FITTING GUIDELINES FOR MODEL:

ALCUDIA.

(These guidelines consist of 9 pages).

Important.

- Please read all of these guidelines and diagrams before commencing any installation.
- This fireplace **must be** installed by an experienced, suitably qualified, and competent fitter.
- The fireplace installation is **NOT** recommended as a DIY or single person installation.
- The fireplace installation **must be** in accordance with Building Regulations, British Standards and any Rules in Force. Current Document J outlines various British Standards that cover all aspects of fireplace installation for England and Wales. The fixing of stonework is covered by BS 8298 “Code of practice for Design and Installation of Natural Stone Cladding and Lining.
- Make reference to the Stone Federation of Great Britain, guidance on fire surrounds.(www.stonefed.org.uk)
- Reference must be made to all Building Regulations and any Rules In Force for areas outside of the UK such as Scotland and Southern Ireland.
- This fireplace must only be installed onto floors with an adequate load-bearing capacity. If an existing construction does not meet this requirement, suitable measures must be taken to rectify. **Must be** in accordance with national laws and regulations & any rules and standards in force
- Should any conflict occur between these guidelines and any applicable regulations and any rules in force then the Regulations and Rules in Force shall apply.
- The fireplace installation **must be** in accordance with planning permission and local building control
- Any solid fuel appliance installation completed in conjunction with this fireplace should be installed by a HETAS (GB only), registered installer or approved by your local building control officer.
- Any electrical connections made whilst fitting this fireplace should meet the requirements of Building regulations and any Rules in Force. The recognised independent body for electric is the National Inspection Council for Electrical Installation Contracting (NICEIC).
- Any gas appliance installation completed in conjunction with this fireplace must be completed by a Gas Safe registered gas engineer, in accordance with the gas fire manufacturer’s instructions.
- Only install the fireplace to a solid brick chimney.
- If the fireplace cannot be permanently fixed to a solid brick chimney, such as block work, studwork, or any structure other than a solid brick chimney, then we recommend that you consult an architect or structural engineer for advice.
- All fireplace mechanical fixings must be stainless steel or at least galvanised steel and be totally corrosion and heat proof and of adequate size and strength to fix fireplace.
- The consequences of failure of a stone fireplace surround incorrectly installed and secured are extremely serious. It is essential that a fireplace surround is installed and secured to withstand foreseeable abuse such as a child pulling down on a cantilevered shelf.
- Always inform the user when the fireplace can be used for the first time taking into account of the full drying times for adhesives etc that have been used.
- Fixing brackets **must be** used.
- Lock wire with anchorage points **must be** used.
- Fixing dowels **must be used** when fitting shelf. The shelf and other overhanging components should be adequately restrained in all instances as they are liable to tip forward so it is imperative this is securely fixed back into the wall so there is no possibility of any piece tipping and falling.
- The fireplace **must be** completely adhered to the chimney brickwork with suitable adhesive. Such products should only be used for applications approved by the manufacturer. If there is any doubt, the adhesive manufacturer should be consulted.
- Gypsum based products is not recommended as an adhesive and should not be used.
- Never use adhesive alone to fit the fireplace
- Brackets, anchorage points and dowels to be fitted against brickwork **not** plaster.

- All mechanical fixings to be chased into mounting wall brickwork to enable complete contact of all rear edges of fireplace to wall so a total bond can be made when also adhering fireplace to wall.
- Ensure all mechanical fixings do not obstruct total face to face contact of any fireplace mating parts.
- Use heat proof white or clear stone silicone adhesive between **all** mating stone pieces. (Ensure to protect fireplace visible stone surfaces from silicone over spill).
- **Never** drag mating stone pieces together when fixing, as this could chip and scratch the stone.
- Grouting of stone joints can be made by using white tile glue ensuring you wash of residue with clean water.
- It is recommended that after installation and when the fireplace has completely dried, that a suitable stone sealer is used to seal all visible stone surfaces.
- You **must** supply and fit, in correct position a data plate showing all correct information in accordance with building regulations and any rules in force.
- Ensure that purpose provided room ventilation is provided in accordance with building regulations and any rules in force.
- Ensure these fitting guidelines together with the fireplace customer care sheet are given to the customer. Subsequently these to be passed on to any new home owner or occupier.

Important.

Ensure the fireplace is fixed to the chimney wall safely and securely and fitted correctly to all regulations, British Standards and any rules in force. If this cannot be achieved **do not fit the fireplace.**

Safety precautions.

- Use all necessary safety clothing, for example:
- Suitable dust masks where there is a risk of dust contamination
- Suitable protective gloves.
- Suitable Protective foot wear.
- Suitable Protective eye goggles.
- Never wear loose clothing or jewellery.
- Ensure long or loose hair is adequately protected, so as not to be a hazard when using tools etc.
- Ensure all fitting tools and equipment to be used are in good working order and safety approved and suitable for the use intended.
- Always comply with all Health & Safety regulations.
- This fireplace has parts that are irregular in shape and above 25kg in weight, therefore installation is recommended for more than one person or suitable lifting equipment to be used.

Types of fires suitable for the above model.

- Multi fuel, or wood burning stoves manufactured to CE standards of compatible size for fireplace, chimney or flue, with a stove rated temperature of less than 100 degrees Celsius to underside of stove to hearth, complying with building regulations and any rules in force.
- Gas stoves manufactured to CE standards of compatible size for fireplace, chimney or flue, with a stove rated temperature of less than 100 degrees Celsius to underside of stove to hearth, complying with building regulations and any rules in force.
- Electric effect fires manufactured and approved to CE standards suitable for fireplace fire opening.

Chimney Type.

- Class 1. The chimney and flue **must be** in accordance with building regulations and any rules in force, with a suitable builders opening and flue, for your chosen fireplace and gas or solid fuel, or electric fire combination.
- Chimneys and flues **must be** swept and tested by an approved chimney sweep prior to fireplace installation.

Fireplace inspection and precautions.

- Before installation the fireplace **must be** thoroughly checked for faults or damage. If any fault or damage is observed the fireplace **must not** be installed and the problems reported to your fireplace supplier. No claims of this nature will be accepted after the fireplace is installed.
- Limestone is soft and therefore can easily be damaged on installation, therefore all precautionary measures must be taken to avoid these situations i.e. taking extreme care when handling stone and always use suitable covers to protect stone whilst using equipment and fixing materials.

Fitting Guidelines.

(To be used in conjunction with diagrams).

Note:

This fireplace will require other fixing materials including:

- Suitable stainless steel screws, washers and wall plugs.
- Suitable stainless steel locking wire and anchorage points (can be suitable stainless steel screws, washers, and wall plugs).
- Suitable heat resistant stone to brickwork silicone adhesive in either white or clear finish. (The silicone adhesive must be temperature rated at least from -50 degrees Celsius to +150 degrees Celsius). For chambers the temperature rating must be from -50 degrees to + 300 degrees Celsius.
- Suitable Thixotropic two part resin chemical anchor glue suitable for stone, brickwork and metal.
- Suitable sealer for stone and brickwork.
- White dry lining wall adhesive or white cement and silver sand for bedding hearth.

Always follow manufacturer's instructions for all adhesives and cements.

- 1) With suitable testing equipment check for live electrical cables or gas pipes and any other obstructions or connections that maybe obscured in the area of intended fireplace installation. If found use a suitably qualified person to remove and make safe.
- 2) Remove all wall coverings and emulsion in area of intended fireplace installation. Ensure the chimney face is completely sound, dry, dust, grease and contamination free before fitting. Seal all fixing areas. (Note: subject to adhesive manufacturer's instructions. The rear edges of all fireplace components are sealed with a stone sealer prior to delivery).
- 3) In properties with traditionally plastered brick walls the plaster can be cut back to enable the fireplace surround to be fixed directly to the brickwork behind. The plaster can then be made good around the fireplace surround. The plaster is cut back and removed from the area of fireplace installation, remove up to approximately 10mm outside the profile of fireplace to be installed. Ensure the chimney brickwork face is completely sound, dry, dust and grease free before fitting. Seal all fixing areas with appropriate sealer. (Note: subject to adhesive manufacturer's instructions. The rear edges of all fireplace components are sealed with a stone sealer prior to delivery). This is good practice as there will always be a risk of the fireplace surround becoming unstable should a failure of the plaster occur.
- 4) Correctly prepare the chimney builders opening and install a suitable throat lintel into correct position.

- 5) Bed hearth level completely using white dry lining wall adhesive or alternatively with 1 part white cement and 5 parts silver sand.
Do not use any coloured cement or sand or any other coloured products as this will discolour the stone.
- 6) Position the legs and adjust position so they will be in correct position with the top header and shelf when eventually fitted, do not fit at this stage. Mark the position of daylight opening. (This is the width between the internal legs and the height from top of hearth to lower edge of top header). Mark fixing positions for the legs. Position the shaped brackets into each hole and slot to each leg and mark the positions of each leg bracket to wall when eventually fitted to the brick chimney. Remove legs and brackets. Drill suitably sized holes in brick chimney in pre marked leg bracket positions to accommodate suitably sized stainless steel wall plugs. Fit wall plugs.
Remove legs and header.
- 7) Bed rear hearth piece level completely into correct position using your previous marks as a guide. Use white dry lining wall adhesive or alternatively with 1 part white cement and 5 parts silver sand.
- 8) Cut vermiculite panels to suitable size, these to be in correct position when the legs and header are eventually fitted. Note: These panels are usually fitted to create a rectangular chamber but it maybe possible to create tapered sides to these panels if this is your choice, but only providing all necessary clearances are adhered to regarding the appliance manufacturers instructions regarding your appliance selection. It is recommended that the vermiculite panels to be at least 50mm above the internal arch header position, this normally will require cutting of panels to clear the throat lintel. When cutting vermiculite panels it is recommended that you score with a knife and then carefully break at this point. When the three vermiculite panels are of correct size then glue to builders opening using heat proof mastic or silicone adhesive. Use heat proof silicone adhesive between all joints of vermiculite and fireplace parts ensuring the silicone is at least 2mm thick as this will allow movement for thermal expansion. **Important: Do not** let water, liquids or moisture come into contact with the Vermiculite boards as they are not tolerant of any such substances.
- 9) Use clear or white heat proof silicone stone adhesive to adhere, complete rear of stone leg edge faces to chimney. Using the brackets provided, fully glue into the holes and grooves to the top of each leg with thixotropic two part resin chemical anchor fixing glue suitable for stone, metal and brickwork and leave to dry. Securely fix to chimney with suitable sized corrosion proof screws, washers and wall plugs.
Important note. To some fireplace models the shaped brackets that have to be glued into position to the legs and header have been changed to strap brackets. If your fireplace has these new strap brackets, use each model fitting guidelines but omit the shaped bracket and use the strap brackets, these are already glued into position and will be required to be pulled tight and permanently fixed to chimney using suitable sized stainless steel, screws, washers and wall plugs. These new strap brackets are positioned alongside the original shaped brackets. All other guidelines for each fireplace model must be observed, including lock wire fixings and adhering to wall with silicone stone adhesive etc, etc.
Using each hole in each internal top leg blocks, lock wire both legs to chimney wall using correct lock wire procedure, and securely fix to chimney with suitable corrosion proof anchorage points.
- 10) Use heat proof white or clear silicone stone adhesive on top of leg faces and to all mating rear edge faces of top header and adhere fully to chimney and legs. Mark the positions of header brackets to wall to each side of top header and drill holes to accommodate suitably sized stainless steel wall plugs. Fit wall plugs.. Securely fix to chimney with suitable sized corrosion proof screws, washers and wall plugs.
Using each hole in each side of internal header reinforcement blocks, lock wire to chimney wall using correct lock wire procedure, and securely fix to chimney with suitable corrosion proof anchorage points.
- 11) Permanently glue the two eyelet fixing brackets to each end of shelf using thixotropic two part resin chemical anchor fixing glue ensuring they are fully pushed into stone and leave to dry.
- 12) Permanently glue the two dowels provided into the two holes provided to each end of the rear surface of shelf using thixotropic two part resin chemical anchor fixing glue suitable for stone, metal and brickwork and leave to dry. Ensure both dowels are glued 50% of their entire length into the stone shelf, the remainder 50% of dowel will be glued into the brickwork chimney at a later stage.
- 13) When dry place the shelf centrally to top header and mark the position of fixing bracket eyelets and dowels to chimney wall. Remove shelf. Drill holes into chimney wall in your pre marked positions for

eyelet fixings to accommodate suitable sized stainless steel wall plugs. Fit wall plugs. Drill suitably sized holes to accommodate dowel fixings. Ensure the drilled dowel holes in brickwork are totally clean and dust free with no contamination.

- 14) Pass stainless steel or galvanised steel locking wire through each hole provided to each end of shelf and leave enough over length to enable fixing to chimney at next stage.
- 15) Permanently fix top shelf centrally to the top header and chimney using firstly silicone stone adhesive to bond shelf to the top header, legs and chimney. The over length locking wires to be positioned above shelf. **Ensure a total bond** has been made to **all** mating pieces including **all** of rear shelf face to chimney. At the same stage use thixotropic two part resin chemical anchor fixing glue to bond shelf dowels into chimney. **Important.** As you are using silicone stone adhesive and thixotropic resin for the dowels ensure the two adhesives do not come into contact with each other when using and fixing. Using suitable sized stainless steel screws and washers through each eyelet fixing to each end of shelf, fully tighten into stainless steel wall plugs. Drill holes into chimney wall to fit suitable sized stainless steel anchorage points in suitable position to both over length lock wire positioned above the shelf. Using stainless steel locking wire to the correct procedure fully tighten and secure to your chimney anchorage points
- 16) Make good the plaster to wall around fireplace surround taking extreme care and protection to ensure there is no plaster contamination to the stone fireplace. (It is advised that when the fireplace has totally dried, to seal all visible surfaces with a suitable stone sealer and let fully dry before carrying out the plaster process).

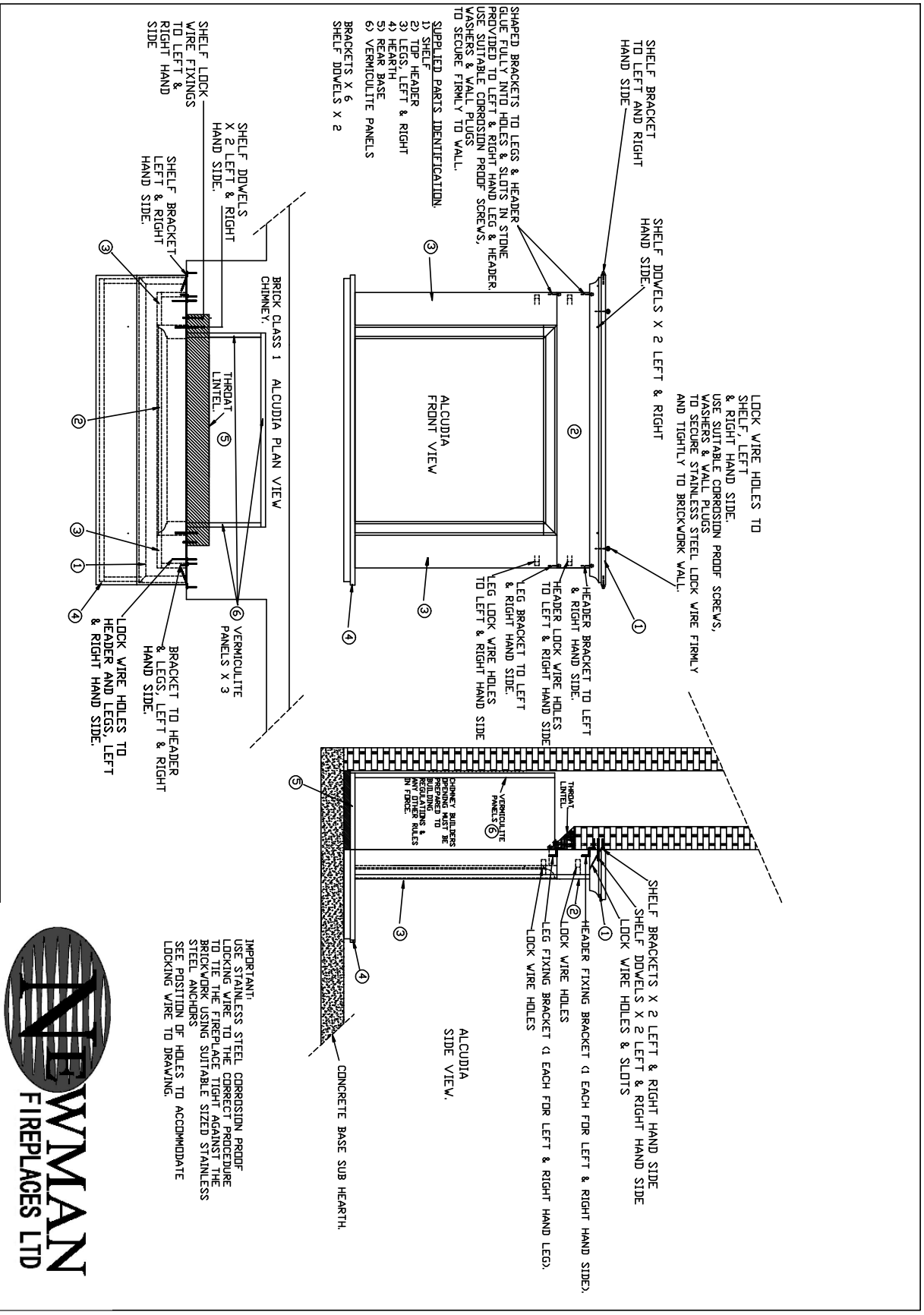

IMPORTANT!
 USE STAINLESS STEEL CORROSION PROOF LOCKING WIRE TO THE CORRECT PROCEDURE TO TIE THE FIREPLACE TIGHT AGAINST THE BRICKWORK USING SUITABLE SIZED STAINLESS STEEL ANCHORS
 SEE POSITION OF HOLES TO ACCOMMODATE LOCKING WIRE TO DRAWING.



THE FIREPLACE DEPENDING ON DATE OF MANUFACTURE CAN HAVE VARYING BRACKETS AND BRACKET LOCATIONS FOR THE LEGS AND TOP HEADERS. IDENTIFY THE VERSION TO THE FIREPLACE SUPPLIED AND REFER TO DRAWINGS BELOW.

VERSION 1. SHAPED BRACKET POSITION TO LEGS AND APPLICABLE TOP HEADERS.

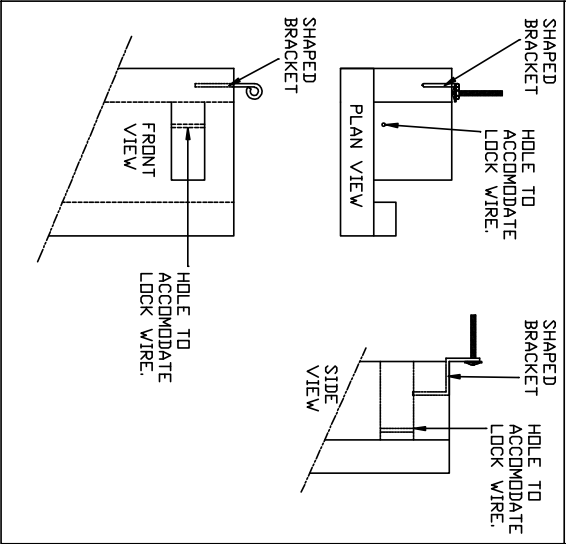

VERSION 2. SHAPED BRACKET POSITION TO LEGS AND APPLICABLE TOP HEADERS.

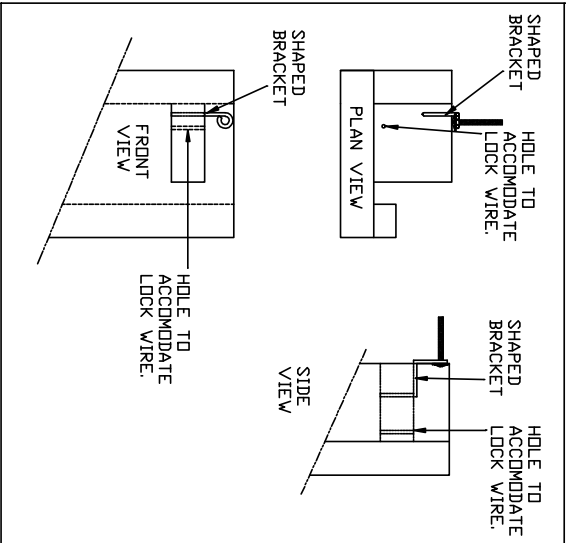

VERSION 3. STRAP BRACKET POSITION TO LEGS AND APPLICABLE TOP HEADERS.

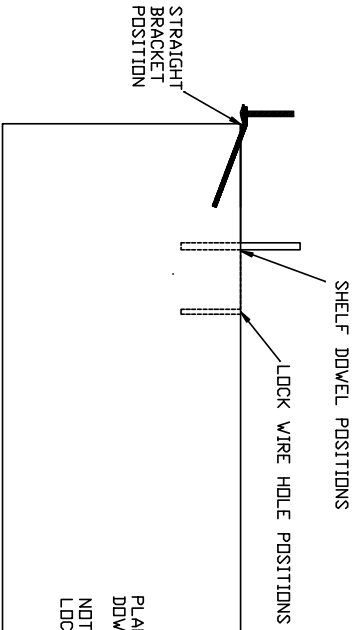
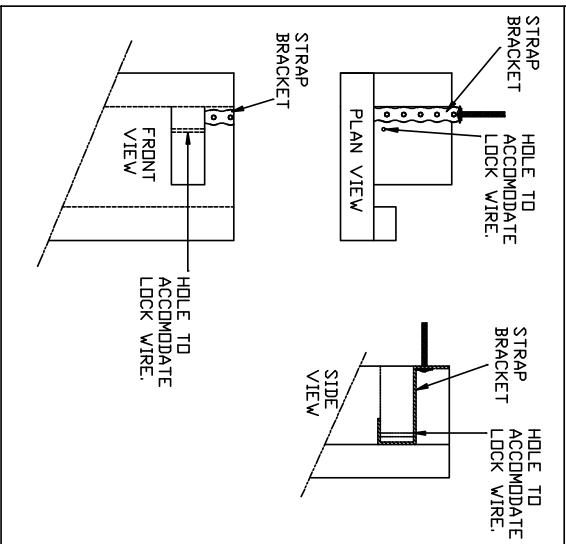

PLAN VIEW OF SHELF SHOWING POSITIONS OF DOWELS, BRACKETS AND LOCK WIRE HOLES TO REAR OF SHELF.
NOTE: POSITIONS OF DOWEL AND LOCK WIRE HOLES CAN VARY.

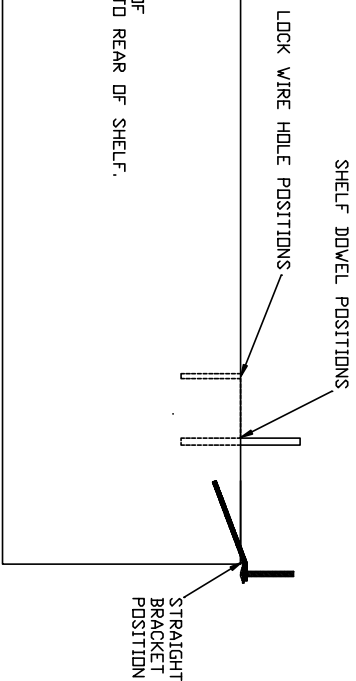

METHOD OF THE FIXING BACK PANELS & ANY OTHER SEPERATE STONE NOT MENTIONED IN FITTING GUIDELINES. NOTE: MUST ALSO BE ADHERED TO ALL MATING SURFACES.

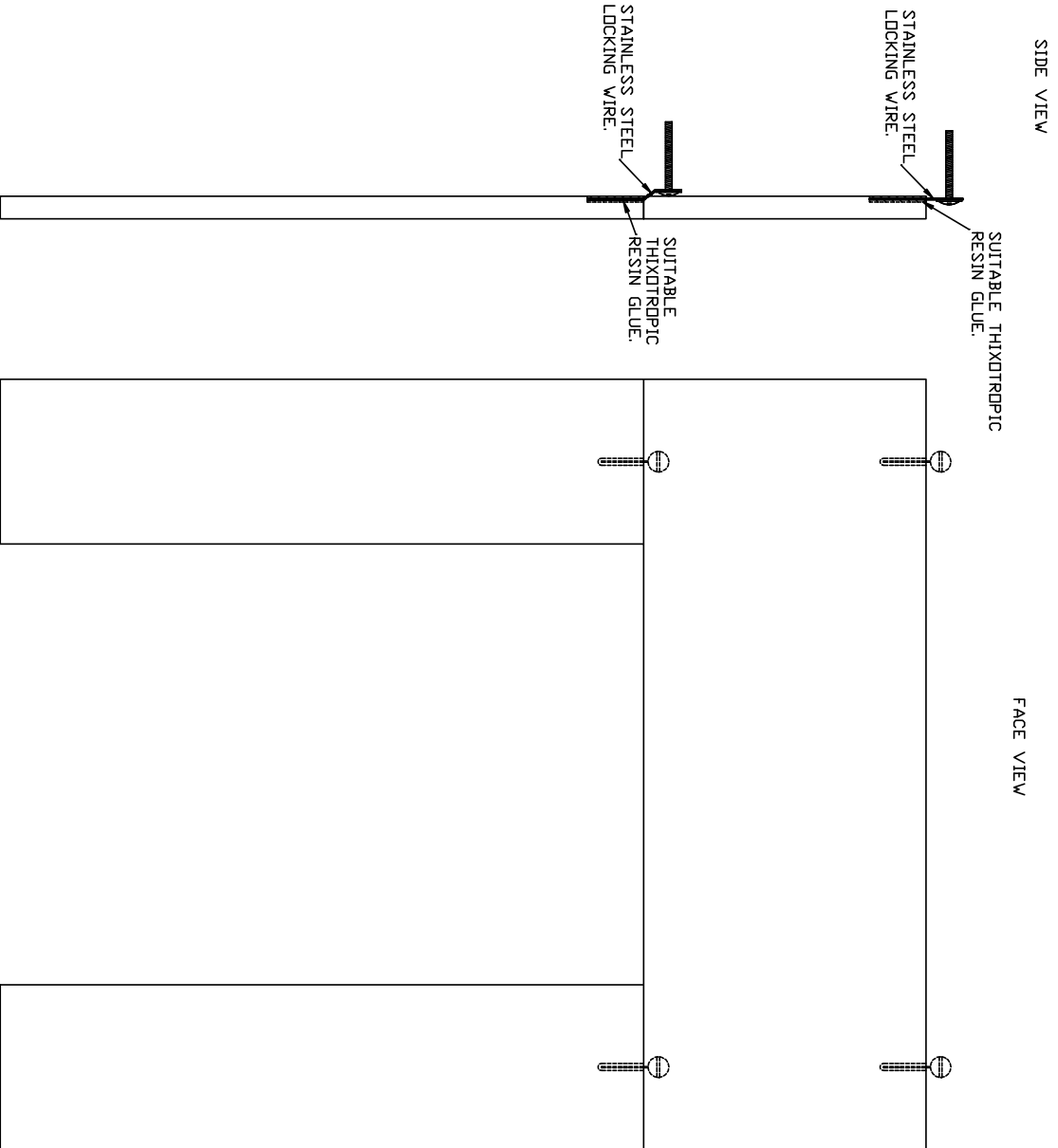

PLAN VIEW
OF SIDE SLIP,
NOT TO SCALE.

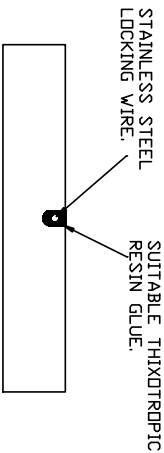

GUIDELINES,
WITH A STONE CUTTING ANGLE GRINDER
MAKE SLOTS TO THE TOP OF SIDE SLIPS
AND TOP SLIP, APPROXIMATE SIZE 50mm
LONG BY 6mm DEEP AND 6mm WIDE.
WITH SUITABLE THIXOTROPIC 2 PART
RESIN BOND ADEQUATE LENGTHS OF
STAINLESS STEEL LOCKING WIRE INTO
THE SLOTS. WHEN DRY USE SUITABLE
STAINLESS STEEL WALL PLUGS, SCREWS
& WASHERS TO SECURELY FIX THE BACK
PANEL TO THE BRICK WALL USING THE
CORRECT LOCK WIRE PROCEDURE TO TIE
THE BACK PANEL TO BRICKWORK.

THIS METHOD CAN BE USED FOR 1
PIECE OR SECTIONED BACK PANELS.